

**TECHNIA**  
ADDNODE GROUP

**LiteCar**  
Vehicle Homologation

EXPERIENCE MATTERS



Professional JT portfolio driven by customer input with solid release cycle

ISO based own JT toolkit with full control and best performance

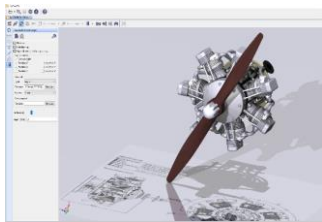

**LiteBox3D**

Desktop and Web Viewing

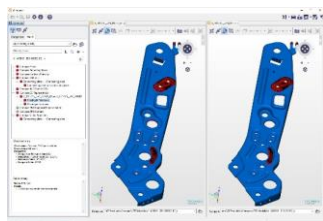

**xCompare**

Validation

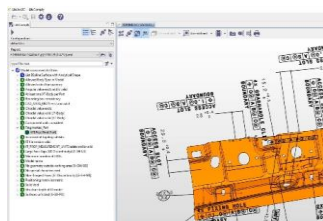

**LiteComply**

Data Quality

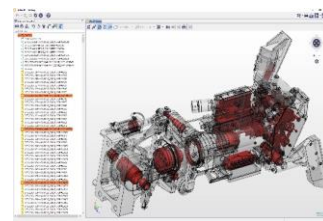

**LiteDrop**

Data Simplification & IP Protection

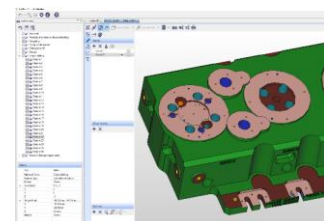

**LiteMachine**

Design to Manufacture

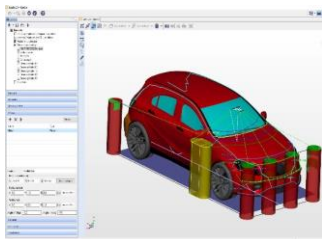

**LiteCar**

Vehicle Homologation

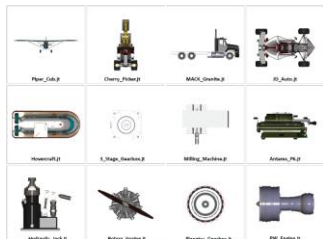

**LiteImage**

Image Capturing (Batch)

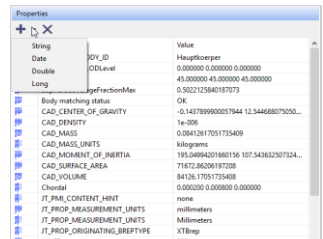

**LiteProperties**

Properties editing (batch)

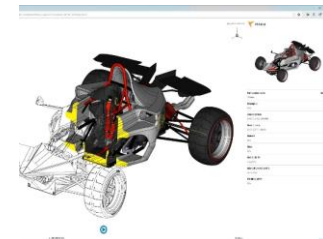

**3DHTML**

3DHTML creator (batch)



**Custom Apps**

LiteSilhouette, LiteCCC, ...

# LiteCar



- Provide Vehicle Homologation functionality based on JT File format
- Current features:
  - Pedestrian Protection
  - Close Range Visibility
  - Bumpers
  - Side Impact
  - Crash Barriers
  - Floor line
  - Safety Radius for Exterior
- More features like in CAVA will be added over time

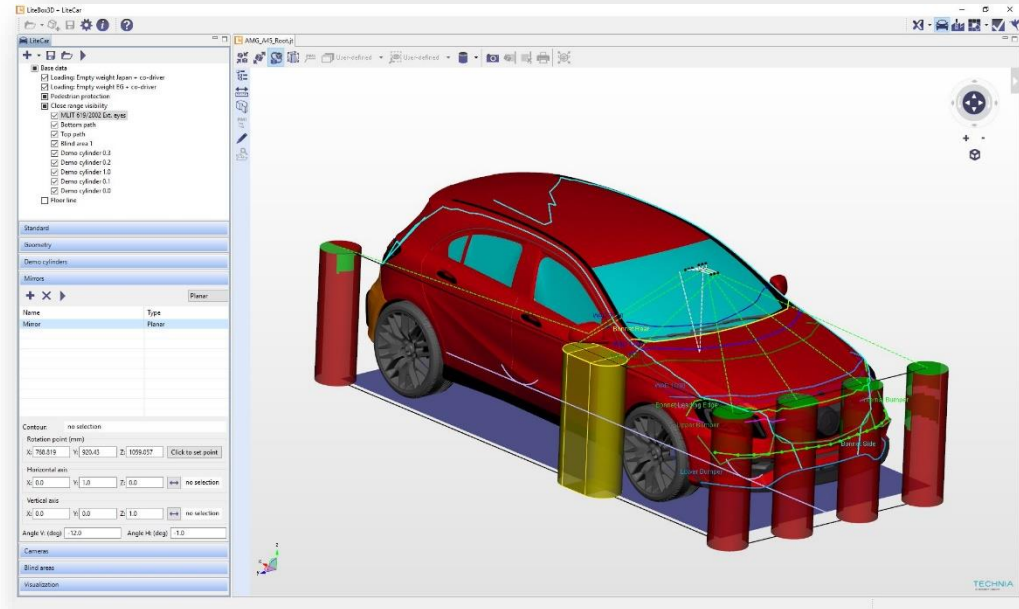

## Scope

LiteCar helps to validate the compliance of your vehicle design and architecture to international rules, norms and standards during the entire design process – from the concept phase to the homologation. LiteCar provides the car designers a tool assuring the observation of car design relevant national and international regulations and standards. Also LiteCar allows the integration of company-internal design and security regulations into the car model. With our 15 years of experience in developing CAVA for CATIA this tremendous functionality is now also available for Non-CATIA customers, using the standardized ISO format JT.

## General functionality

- Base Data definition  
General data of the vehicle defining its skeletal structure that are used for the most of the LiteCar functions. Once the base data is specified, it is available consistently for all LiteCar functions.
- Regulations  
Standards are embedded as free editable xml files. Thus company-internal rules or changes in standards can be integrated easily without need for a software update.
- Results  
All results including LiteCar generated geometry features are stored in a xml report file, e.g. for import into a CAD System

- Base data
  - Loading: Empty weight EG
  - Loading: Empty weight Japan + co-driver
  - Loading: Empty weight EG + co-driver
  - Floor line
  - Pedestrian protection
  - Close range visibility

```

- name
- out_offset
- in_offset
- in_length
- calculation
- loading
- rear_loading
values: "tangential", "tangent_parallel" or "horizontal" (inner lines)
Loading string, if not defined, a value from standard element is used
rear loading string, if not defined, a value from standard element is used
-->
</DynamicCurb>
<standard name="Company Intern" loading="Overall weight HL3">
  <description>This is a description to the standard</description>
  <category name="default" out_offset="210mm" in_offset="160mm" in_length="300mm" calculation="horizontal"/>
  <category name="Off-Roader" loading="Empty weight EG" out_offset="240mm" in_offset="210mm" in_length="300mm" calculation="horizontal"/>
</standard>
<standard name="New" loading="Overall weight HL3">
  <description>This is a description to the standard</description>
  <category name="default" out_offset="210mm" in_offset="160mm" in_length="300mm" calculation="horizontal"/>
  <category name="Off-Roader" loading="Empty weight EG" out_offset="240mm" in_offset="210mm" in_length="300mm" calculation="horizontal"/>
</standard>
<standard name="Company Intern V4 style" loading="Overall weight HL3">
  <description>This is a description to the standard</description>
  <category name="default" out_offset="210mm" in_offset="160mm" in_length="300mm" calculation="tangent_parallel"/>
  <category name="Off-Roader" out_offset="240mm" in_offset="210mm" in_length="300mm" calculation="tangent_parallel"/>
</standard>
</DynamicCurb>

```

Create company specific standards

## Pedestrian Protection

Standards for pedestrian protection have to be considered in vehicle development. For example, since 2005 Europe has pertinent legislation for the protection of pedestrians. In addition there is the EURO NCAP directive, which while not being binding for homologation still has a very high marketing impact.

Within the individual legislation various ranges and curves are defined, which mean certain requirements for a crash test.

Supported standards: Euro NCAP, GTR, ECE R-127

Calculation of:

- WAD curves
- Bonnet-Leading
- Bonnet-Side
- Bonnet-Rear
- Upper Bumper
- Lower Bumper
- Corner of Bumper
- Internal Bumper
- Upper Leg Grid
- Lower Leg Grid
- Bonnet Top Grid

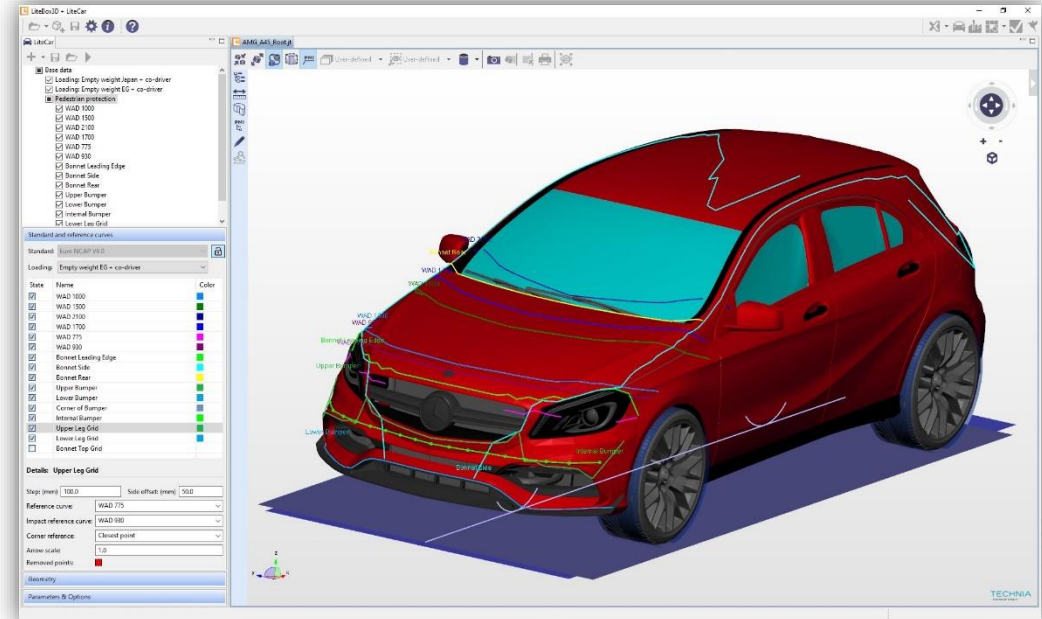

## Close Range Visibility

The Japanese visibility law (MLIT Announcement 619/2002 Att.81) requires the visibility of an „obstacle“ for the driver by direct view or by using a mirror or other optical systems. The obstacle, which is defined as a cylinder with a height of 1 m and a diameter of 0,3 m, must be visible (even partly) in a defined range in front of and beside the driver.

Supported standards: MLIT Standards MLIT 619/2002 Att.81 – BaseData, MLIT 619/2002 Att.81 - Contact und MLIT 619/2002 Att.29 – Frontal

### Features:

- Positioning of simple and detailed demo cylinders
- Including planar, spherical, a-spherical and custom mirrors
- Including cone, square and customer shape cameras

### Result:

- Visualization of blind spot areas and assessment if within or outside of permitted limits

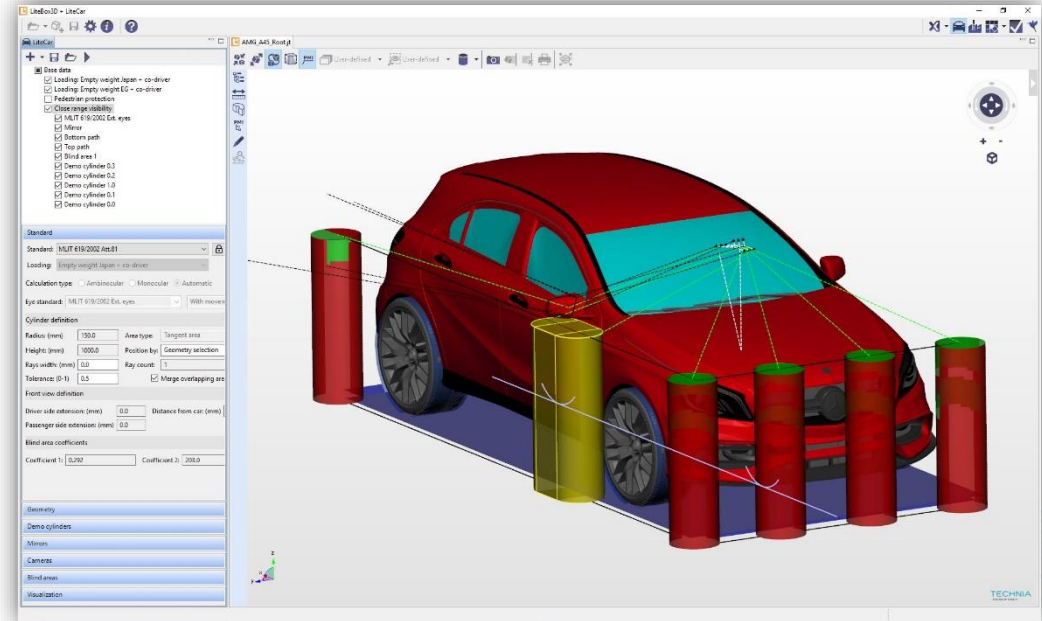

## Floor line

The Floor line is required by the European standards EEC 74 / 483 and ECE-R 26 that define minimal allowed radii inside the “reachable” areas of the vehicle outer geometry. The „reachability“ of the surfaces is checked by a sphere with a defined diameter (100 mm). In these areas, the surface must have a curvature radius that is above a specific limit (e.g. 2,5 mm).

The check region of the vehicle geometry is limited by the standard 2m above the road plane and as lower limit by the floor line.

Features:

- Calculation of the floor line
- Including consideration of wheel opening

Result:

- Visualization of the floor line

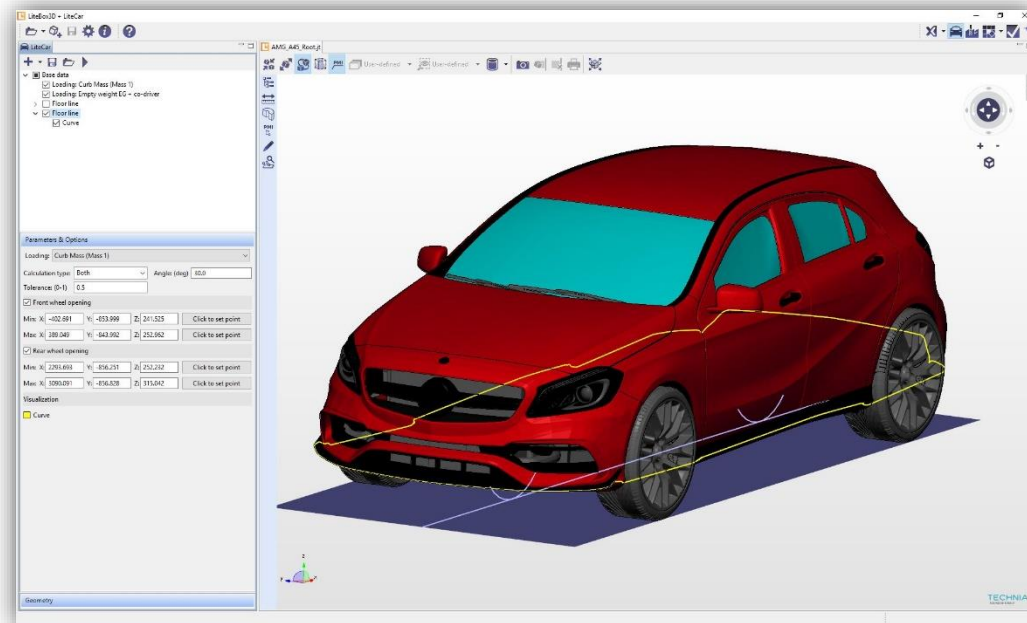

# Bumpers

This feature checks the vertical position of bumpers according to applicable regulations.

Supported standards:

ECE-R 42

US 49 CFR 81

CDN CVMSS 215

Features:

- Positioning of middle, rotated, and shifted pendulums
- User defined pendulum profiles

Result:

- Visualization of bumper geometry

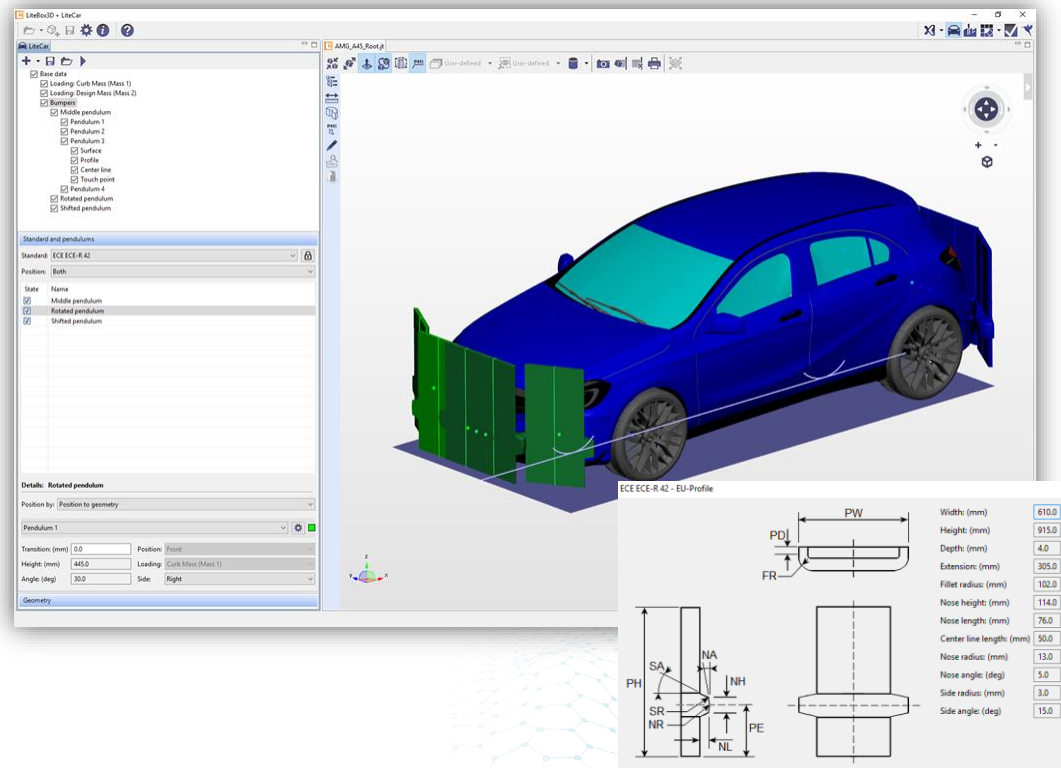



# Crash Barriers

This feature facilitates positioning crash barriers.

Supported standards: RCAR and IIHS

Features:

- Positioning of crash barriers
- User defined barrier profiles
- Entry Card: This option calculates the qualifying bumper beam height and relevant vertical bumper engagement, according to the RCAR test procedure.

Result:

- Visualization of crash barriers geometry
- Entry Card

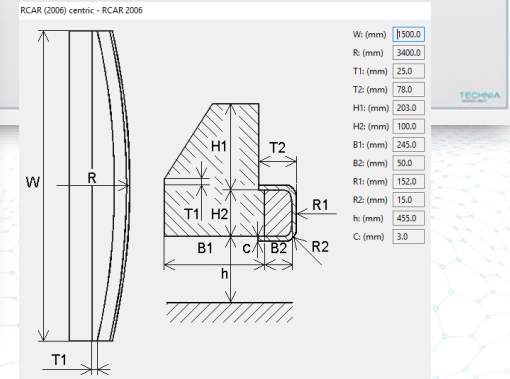
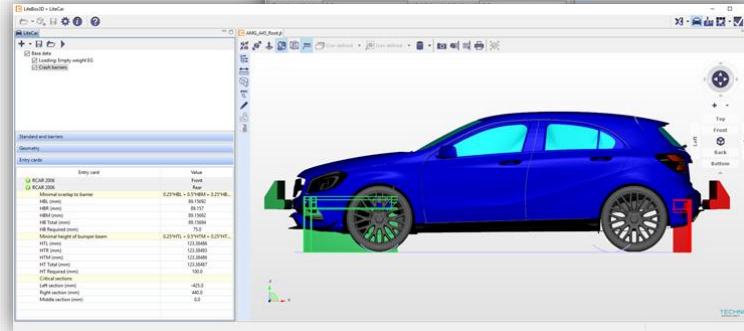
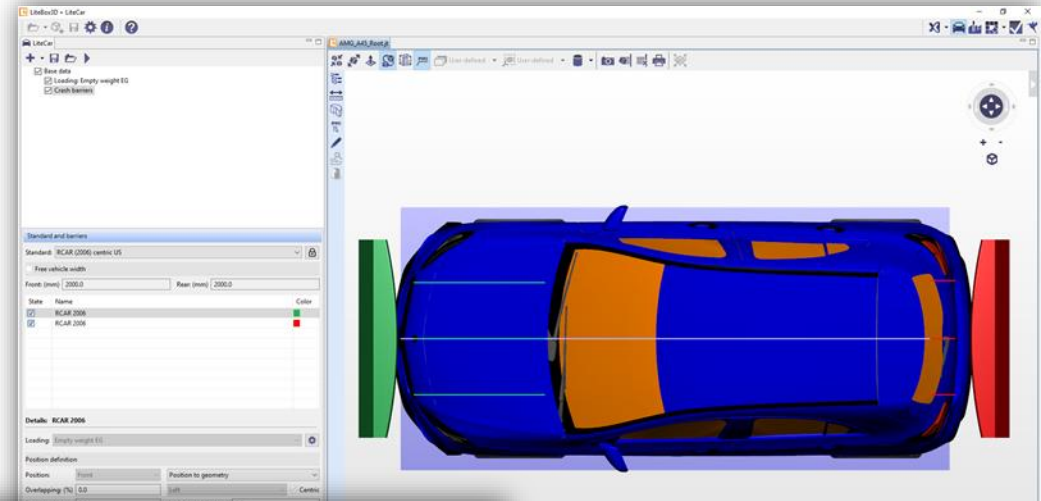

## Side Impact

This feature facilitates positioning the barriers according to applicable standards. The crash test procedures are performed to verify the ability to prevent injury of passengers.

Supported standards: Euro NCAP, FMVSS, and IIHS

Features:

- Positioning of crash barriers
- User defined barrier profiles

Result:

- Visualization of barrier geometry

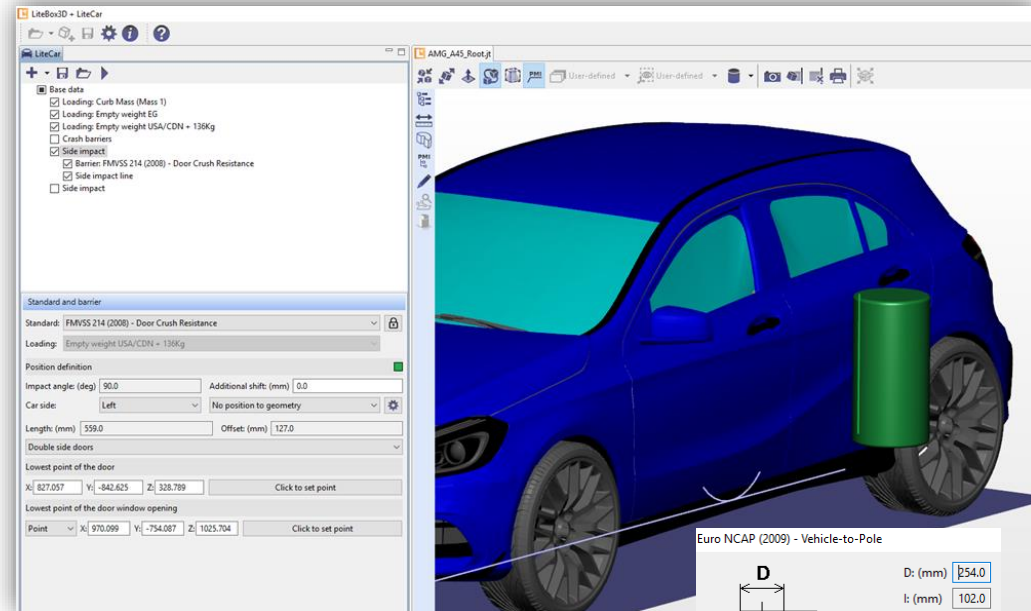

## Safety Radius

The safety radius feature checks the curvature radius of external projections of a vehicle.

The check applies to reachable areas of the vehicle exterior, that is, areas which can be contacted by a sphere of a defined diameter. Certain areas of the vehicle exterior like bumpers, headlights, grilles and gaps can be checked separately.

Supported standards: ECE-R26

Calculations:

- General radius-check
- Bumper check
- Head lamp and grill check
- Consideration of upper limit and floor line

Results:

- Visualization of grid points by category
- For selected points, additionally the coordinates, curvature radius and gap dimension of check points and visualization of the safety radius measuring device.

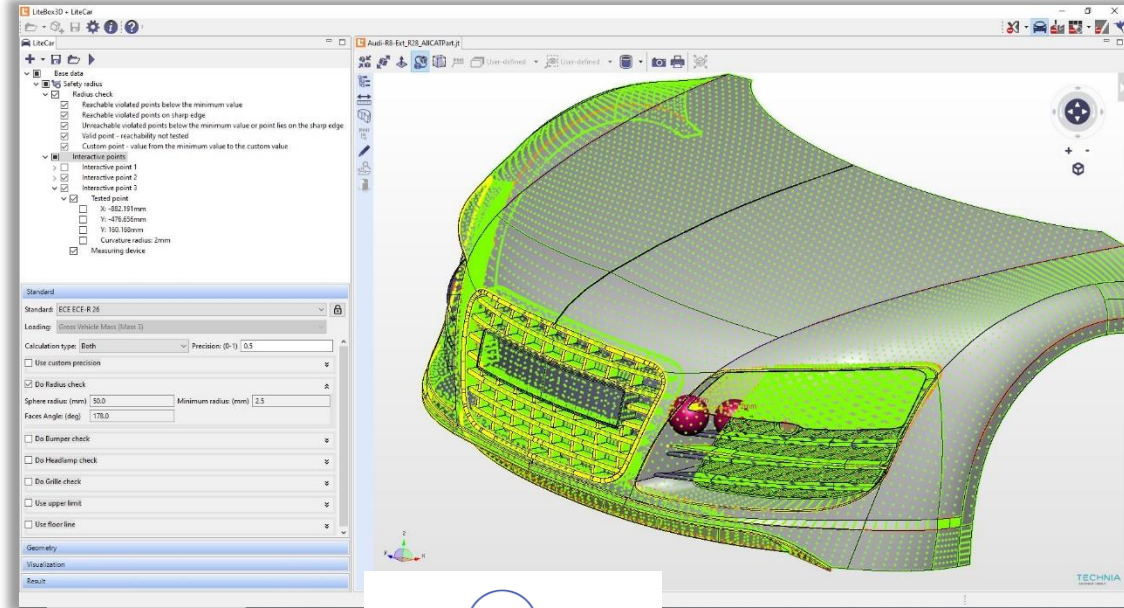

## Business Issue

- Automotive design needs to be compliant to many international standards and regulations.
- Manual verification of the compliance of the evolving design requires high effort and is subject to human errors.

## Solutions

- LiteCar provides analysis features to verify the compliance of CAD models to international standards and regulations (ECE, GTR, Euro NCAP, FMVSS, RCAR, ..)
- LiteCar is integrated into TECHNIA's Lite3D platform

## Benefits

- Less need for physical prototypes due to validation of the digital model.
- Easy access to the provided standards and managing of car parameters.
- Applicable during all phases of the design process, from concept to homologation.
- Gain 15 years of experience in vehicle homologation and the knowledge of the CAVA community. CAVA is a proven solution and successfully used by more than 100 OEMs and suppliers world-wide.



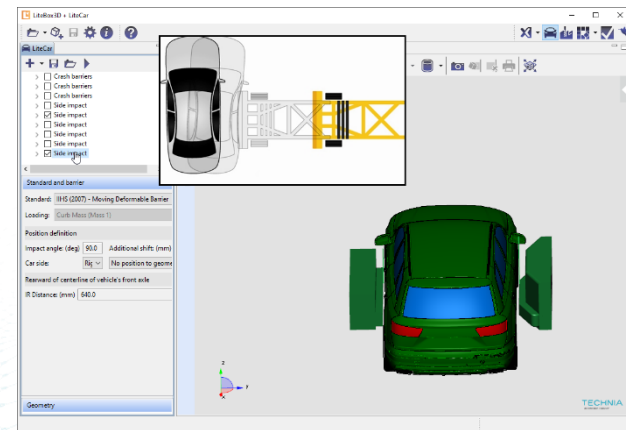
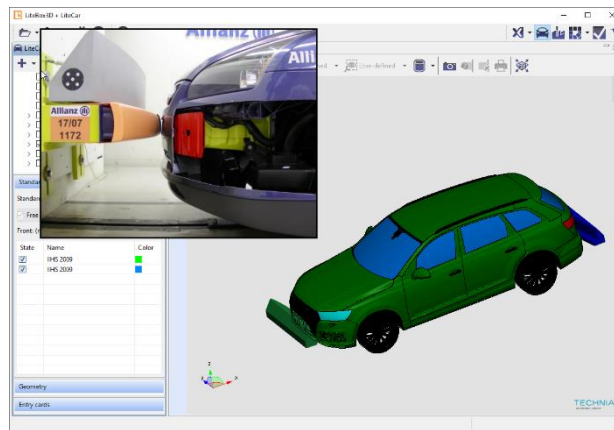
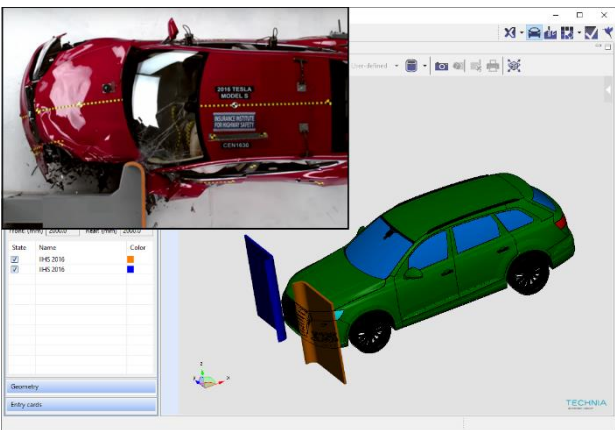
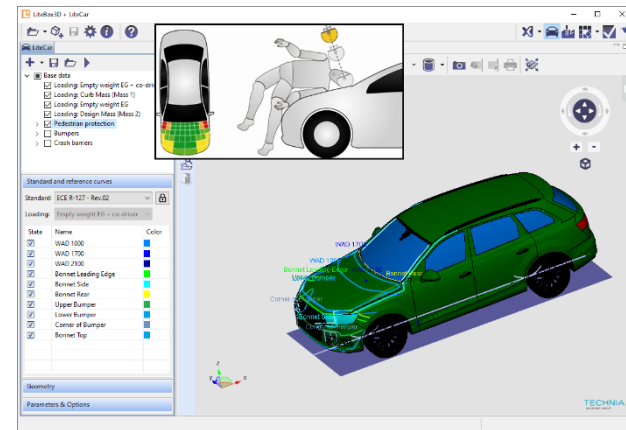
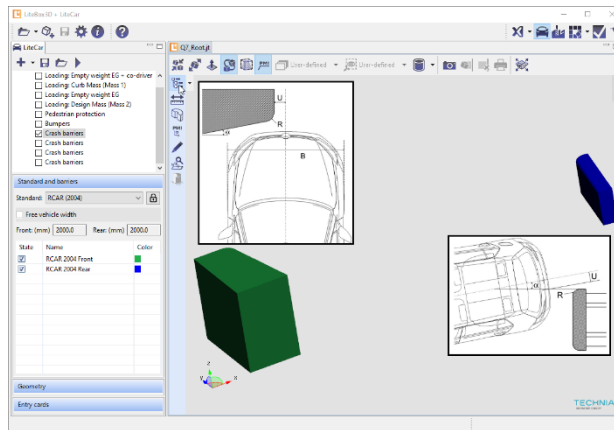
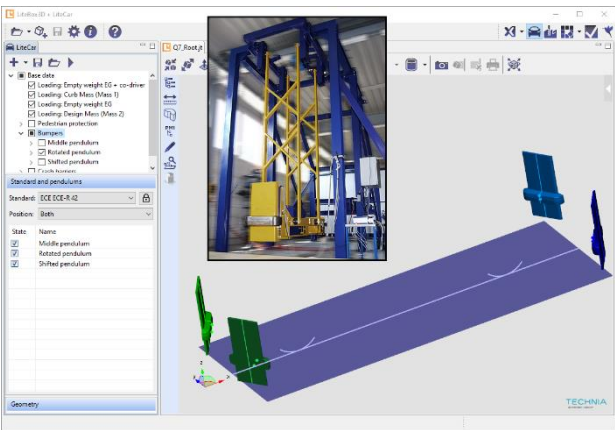

# If you looking for more, please look at CAVA and let us know what you are missing in LiteCar...

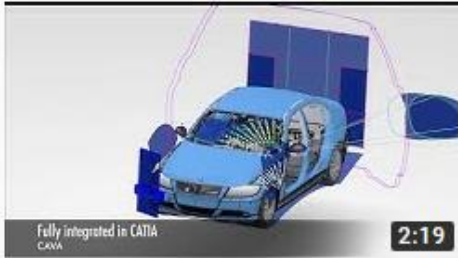

## CAVA - CATIA Solution for Car Design and Legal Compliance

TechniaDACH • 35 Aufrufe • vor 2 Monaten

Sichern Sie die Einhaltung internationaler Normen und Standards schon ab Entwurfsphase Ihres Fahrzeugs - mit Hilfe von CAVA ...

<https://www.youtube.com/watch?v=psVRCQmzNMs>



### CAVA - Manikin

- Provides the SAE Template in different percentage sizes and practical positioning and measuring methods
  - Input seat/hair points from Base Data feature or selected geometry like floor or panel
  - Angle parameters from user input / Base Data feature
  - Measure Mass and D10, Legroom, joint angles and positions
  - Optimal Clavh Detection
- Eye points / Eye ellipses
  - According European standards for points (D-, R-, V-Points)
  - According SAE J541 standards for ellipses
- Head Rest Measuring device
  - FMVSS 202A, NCAP

## Check your (automotive) design against international standards with CAVA

TECHNIA AB • 116 Aufrufe • vor 7 Monaten

TT Software Webinar Series 3: • Checks for Vehicle Architecture and Manikin • Direct Vision and Wiper • Mirrors, Sensors, ...

<https://www.youtube.com/watch?v=hvs9pPsxkqU>



# TECHNIA

At TECHNIA, we pave the way for your innovation, creativity and profitability. We combine industry-leading Product Lifecycle Management tools with specialist knowledge, so you can enjoy the journey from product concept to implementation.

Our experience makes it possible to keep things simple, personal and accessible so that together we transform your vision into value.

With over 30 years' experience, more than 6000 Customers worldwide and World-class knowledge in PLM & Intelligent Engineering, we work together as an extension of your team to create an exceptional PLM experience.

Our teams work from 21 locations around the world, across vertical industries, delivering a premium service with a global infrastructure and a local presence. We adopt the latest technology and agile methodologies so, even as technology changes, our relationships last a lifetime.

[www.technia.com](http://www.technia.com)  
[info@technia.com](mailto:info@technia.com)

