

TECHNIA

ADDNODE GROUP



Lite3D

Establish 3D as an affordable common collaboration language beyond engineering throughout the extended enterprise.

EXPERIENCE PACKAGED



Professional JT portfolio driven by customer input with solid release cycle

ISO based own JT toolkit with full control and best performance

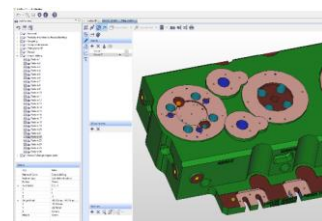
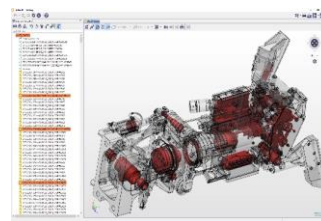
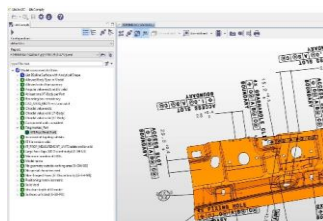
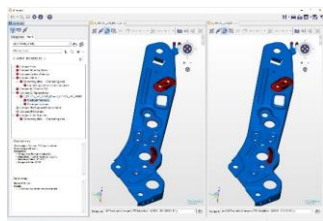
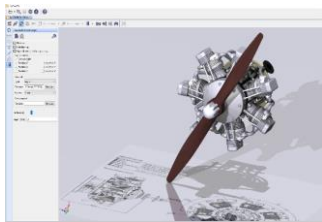

LiteBox3D

Desktop and Web Viewing

xCompare

Validation

LiteComply

Data Quality

LiteDrop

Data Simplification & IP Protection

LiteMachine

Design to Manufacture

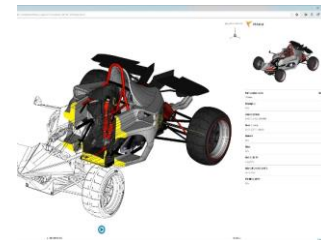
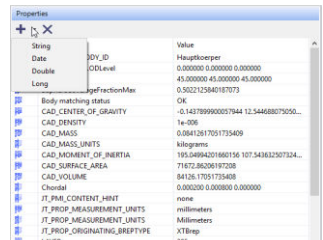
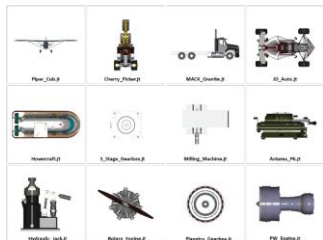
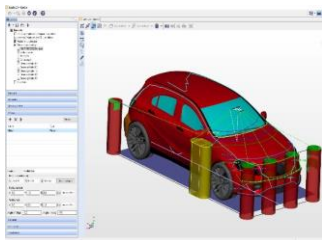

LiteCar

Vehicle Homologation

LiteImage

Image Capturing (Batch)

LiteProperties

Properties editing (batch)

3DHTML

3DHTML creator (batch)

Custom Apps

LiteSilhouette, LiteCCC, ...

Data Clearing – IP Protection and Simplification

Extract process specific content & IP from a Master JT file

High performance JTs with just what's needed and you want to share

Removal of invisible parts

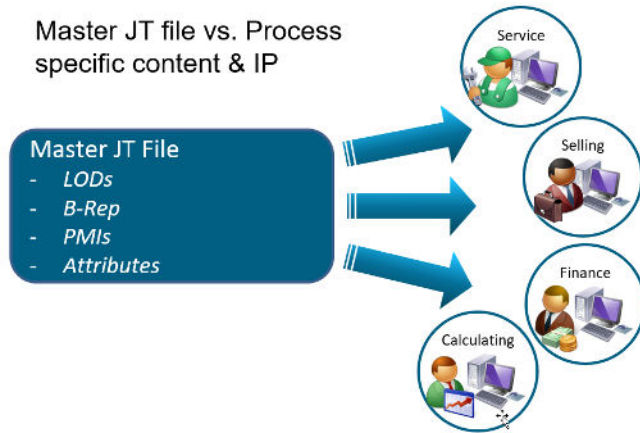

Bidding & Inquiry
- LODs (low accuracy) only

High end Visualization
- B-Rep only

Manufacturing / Shop floor
- LOD & PMIs

After Sales
- LOD (finest) & Properties

Others.... i.e. viewing by web
- As small as possible

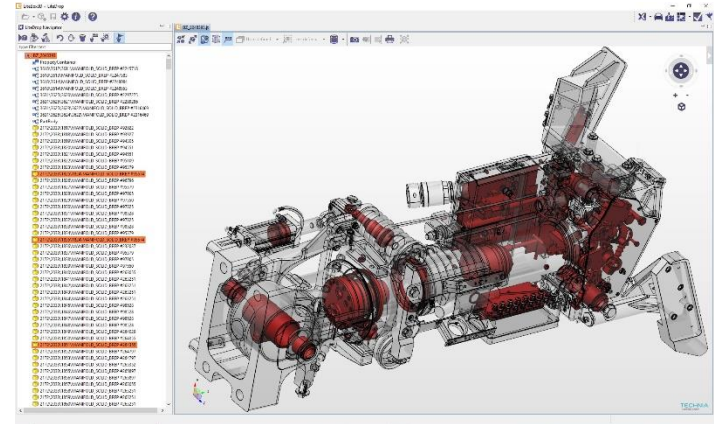

LiteDrop



- Remove specific content / nodes of the JT file
 - By type, i.e. XT / JT B-Rep, PMIs, LODs + number
 - By name, i.e. specific properties only
 - Remove invisible Parts / inner bodies
- Reduce file size for processes which do not require all details
- Interactive integration in LiteBox3D & Batch for automated processes

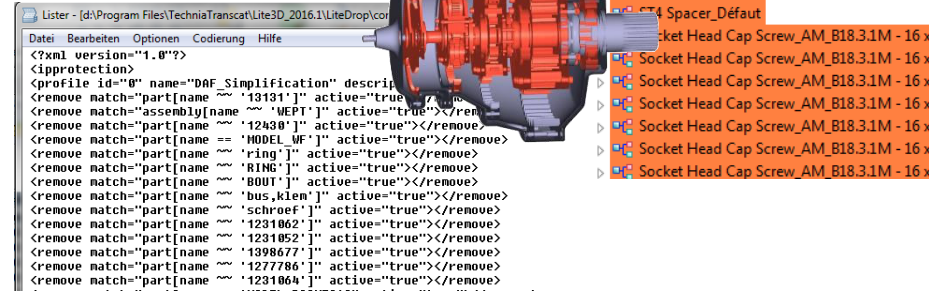
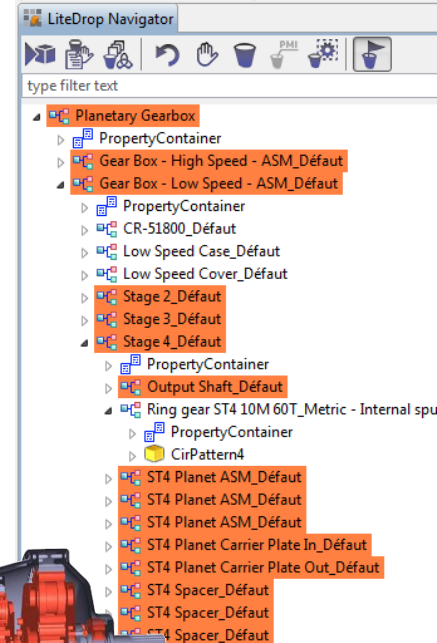

LiteDrop

Video

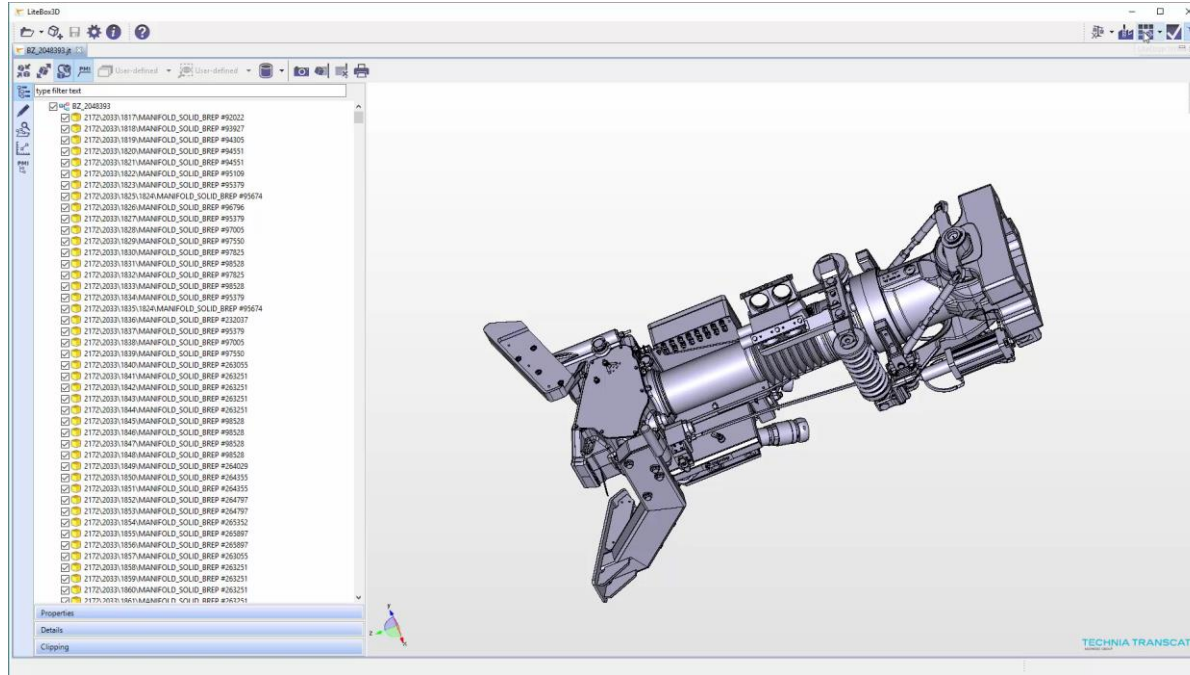

https://www.youtube.com/watch?v=D3VWZcq_iRM

TECHNIA

ADDNODE GROUP



+49 721 970 43 74



arnd.feye@technia.com

EXPERIENCE MATTERS

